

Blume

BLTD - BLT

DESIGN
Sebastian Herkner

PEDRALI[®]

100%
MADE IN
ITALY



EN: Coffee table with an aluminum structure, featuring a flower-shaped profile and marble, composite marble or solid laminate tops

IT: Tavolino con struttura in alluminio con profilo a forma di fiore e ripiano in marmo, agglomerato di marmo o stratificato

DE: Couchtisch mit Aluminiumgestell mit blumenförmigem Profil und Marmor-, Marmoragglomerat- oder Schichtplatte

FR: Table basse avec structure en aluminium avec profil en forme de fleur et plateau en marbre, marbre aggloméré ou stratifié

ES: Mesita con estructura en aluminio con perfil en forma de flor y sobre de mármol, aglomerado de mármol o compacto

mm - in

* Table height increases of 1 cm for marble top versions

L'altezza del tavolo aumenta di 1 cm per le versioni con ripiano in marmo

• BLTD_49X30*

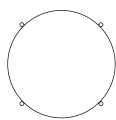
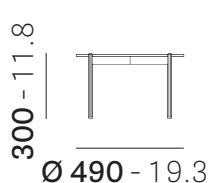

Disassembled
Da assemblare

THICKNESS TOP

SOLID LAMINATE	MARBLE	COMPOSITE MARBLE
10mm - 0.39"	12mm - 0.47"	20mm - 0.79"
		12mm - 0.47"

• BLTD_89X30*

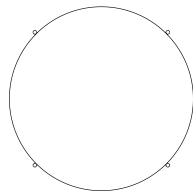
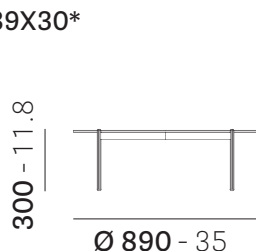

Disassembled
Da assemblare

THICKNESS TOP

SOLID LAMINATE	MARBLE	COMPOSITE MARBLE
10mm - 0.39"	12mm - 0.47"	20mm - 0.79"
		12mm - 0.47"

• BLT_50X35X30*

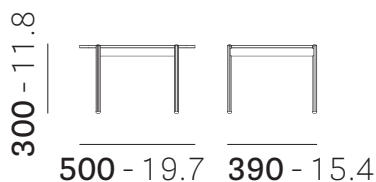

Disassembled
Da assemblare

THICKNESS TOP

SOLID LAMINATE	MARBLE	COMPOSITE MARBLE
10mm - 0.39"	12mm - 0.47"	20mm - 0.79"
		12mm - 0.47"

• BLT_90X60X30*

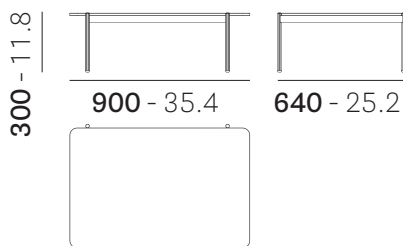

Disassembled
Da assemblare

THICKNESS TOP

SOLID LAMINATE	MARBLE	COMPOSITE MARBLE
10mm - 0.39"	12mm - 0.47"	20mm - 0.79"
		12mm - 0.47"

Reproduction of this document is strictly prohibited without prior written authorisation from Pedrali SpA. Sizes, weights and finishes may change without previous notice. È vietata la riproduzione del seguente documento senza previa autorizzazione scritta da parte di Pedrali SpA. Dimensioni, pesi e finiture possono variare senza alcun preavviso.

ST_BLUME_BLT_BLTD_2021.0

BLTD - BLT

DESIGN
Sebastian Herkner

• BLT_69X69X30*

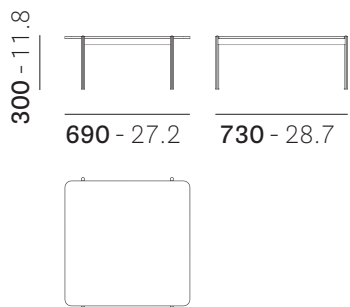

Disassembled
Da assemblare

THICKNESS TOP			
SOLID LAMINATE		MARBLE	COMPOSITE MARBLE
10mm - 0.39"	12mm - 0.47"	20mm - 0.79"	12mm - 0.47"

• BLT_99X99X30*

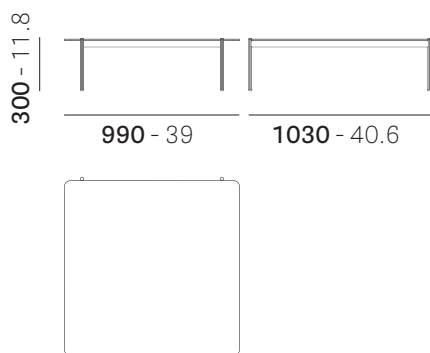

Disassembled
Da assemblare

THICKNESS TOP			
SOLID LAMINATE		MARBLE	COMPOSITE MARBLE
10mm - 0.39"	12mm - 0.47"	20mm - 0.79"	12mm - 0.47"

• BLT_100X25X30*

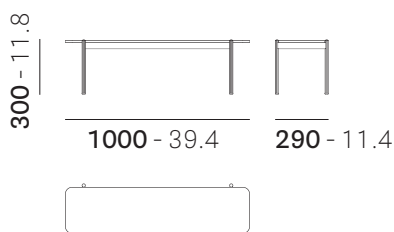

Disassembled
Da assemblare

THICKNESS TOP			
SOLID LAMINATE		MARBLE	COMPOSITE MARBLE
10mm - 0.39"	12mm - 0.47"	20mm - 0.79"	12mm - 0.47"

• BLTD_49X37*

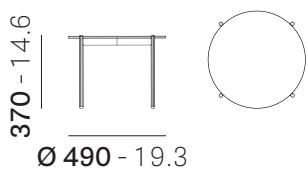

Disassembled
Da assemblare

THICKNESS TOP			
SOLID LAMINATE		MARBLE	COMPOSITE MARBLE
10mm - 0.39"	12mm - 0.47"	20mm - 0.79"	12mm - 0.47"

Reproduction of this document is strictly prohibited without prior written authorisation from Pedrali SpA. Sizes, weights and finishes may change without previous notice.
 È vietata la riproduzione del seguente documento senza previa autorizzazione scritta da parte di Pedrali SpA. Dimensioni, pesi e finiture possono variare senza alcun preavviso.

ST_BLUME_BLT_BLTD_2021.0

BLTD - BLT

DESIGN
Sebastian Herkner

• BLTD_89X37*

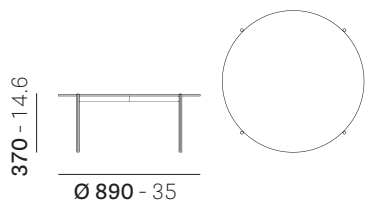

Disassembled
Da assemblare

THICKNESS TOP

SOLID LAMINATE		MARBLE		COMPOSITE MARBLE	
10mm - 0.39"	12mm - 0.47"	20mm - 0.79"		12mm - 0.47"	

• BLT_50X35X37*

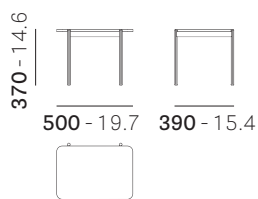

Disassembled
Da assemblare

THICKNESS TOP

SOLID LAMINATE		MARBLE		COMPOSITE MARBLE	
10mm - 0.39"	12mm - 0.47"	20mm - 0.79"		12mm - 0.47"	

• BLT_90X60X37*



Disassembled
Da assemblare

THICKNESS TOP

SOLID LAMINATE		MARBLE		COMPOSITE MARBLE	
10mm - 0.39"	12mm - 0.47"	20mm - 0.79"		12mm - 0.47"	

• BLT_69X69X37*

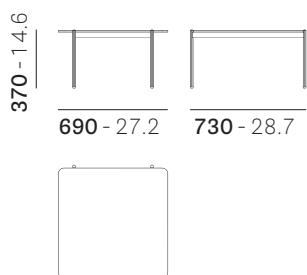

Disassembled
Da assemblare

THICKNESS TOP

SOLID LAMINATE		MARBLE		COMPOSITE MARBLE	
10mm - 0.39"	12mm - 0.47"	20mm - 0.79"		12mm - 0.47"	

• BLT_99X99X37*

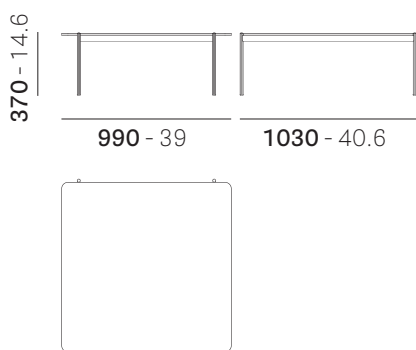

Disassembled
Da assemblare

THICKNESS TOP

SOLID LAMINATE		MARBLE		COMPOSITE MARBLE	
10mm - 0.39"	12mm - 0.47"	20mm - 0.79"		12mm - 0.47"	

Reproduction of this document is strictly prohibited without prior written authorisation from Pedrali SpA. Sizes, weights and finishes may change without previous notice. È vietata la riproduzione del seguente documento senza previa autorizzazione scritta da parte di Pedrali SpA. Dimensioni, pesi e finiture possono variare senza alcun preavviso.

ST_BLUME_BLT_BLTD_2021.0

BLTD - BLT

DESIGN
Sebastian Herkner

• BLT_100X25X37*

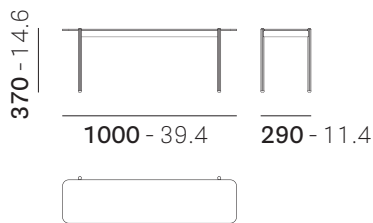

Disassembled
Da assemblare

THICKNESS TOP

SOLID LAMINATE		MARBLE		COMPOSITE MARBLE
10mm - 0.39"	12mm - 0.47"	20mm - 0.79"	12mm - 0.47"	12mm - 0.47"

• BLTD_49X45*

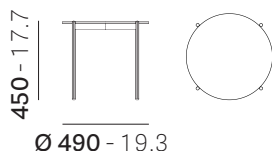

Disassembled
Da assemblare

THICKNESS TOP

SOLID LAMINATE		MARBLE		COMPOSITE MARBLE
10mm - 0.39"	12mm - 0.47"	20mm - 0.79"	12mm - 0.47"	12mm - 0.47"

• BLTD_89X45*

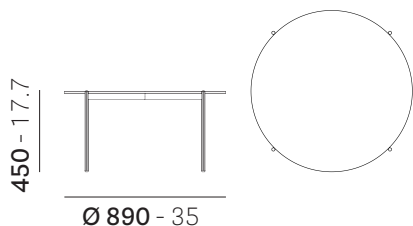

Disassembled
Da assemblare

THICKNESS TOP

SOLID LAMINATE		MARBLE		COMPOSITE MARBLE
10mm - 0.39"	12mm - 0.47"	20mm - 0.79"	12mm - 0.47"	12mm - 0.47"

• BLT_50X35X45*

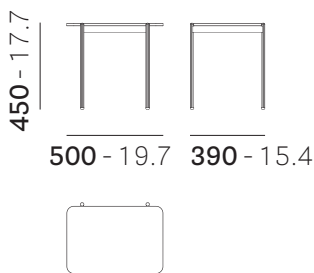

Disassembled
Da assemblare

THICKNESS TOP

SOLID LAMINATE		MARBLE		COMPOSITE MARBLE
10mm - 0.39"	12mm - 0.47"	20mm - 0.79"	12mm - 0.47"	12mm - 0.47"

• BLT_90X60X45*

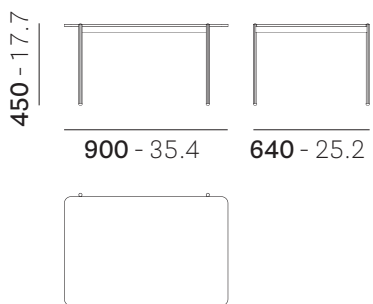

Disassembled
Da assemblare

THICKNESS TOP

SOLID LAMINATE		MARBLE		COMPOSITE MARBLE
10mm - 0.39"	12mm - 0.47"	20mm - 0.79"	12mm - 0.47"	12mm - 0.47"

Reproduction of this document is strictly prohibited without prior written authorisation from Pedrali SpA. Sizes, weights and finishes may change without previous notice. È vietata la riproduzione del seguente documento senza previa autorizzazione scritta da parte di Pedrali SpA. Dimensioni, pesi e finiture possono variare senza alcun preavviso.

ST_BLUME_BLT_BLTD_2021.0

BLTD - BLT

DESIGN
Sebastian Herkner

• BLT_69X69X45*

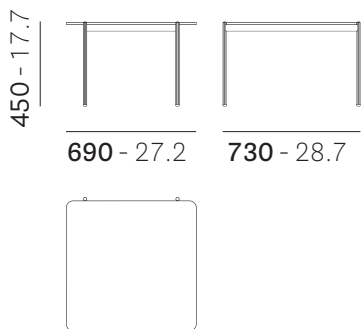

Disassembled
Da assemblare

THICKNESS TOP

SOLID LAMINATE		MARBLE	COMPOSITE MARBLE	
10mm - 0.39"	12mm - 0.47"	20mm - 0.79"	12mm - 0.47"	

• BLT_99X99X45*

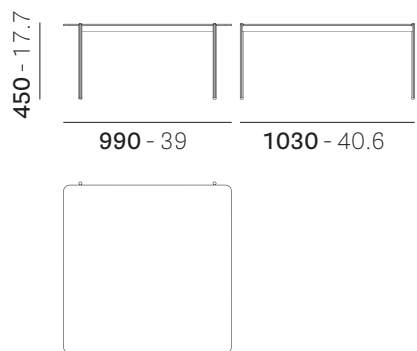

Disassembled mc 0,168
Da assemblare ft³ 5.9

SOLID LAMINATE		MARBLE	COMPOSITE MARBLE	
10mm - 0.39"	12mm - 0.47"	20mm - 0.79"	12mm - 0.47"	



kg 18,43 lb 40.6	kg 21,08 lb 46.5	kg 65,44 lb 144.3	kg 43,93 lb 96.8
---------------------	---------------------	----------------------	---------------------

• BLT_100X25X45*

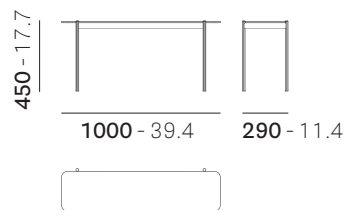

Disassembled
Da assemblare

THICKNESS TOP

SOLID LAMINATE		MARBLE	COMPOSITE MARBLE	
10mm - 0.39"	12mm - 0.47"	20mm - 0.79"	12mm - 0.47"	

Reproduction of this document is strictly prohibited without prior written authorisation from Pedrali SpA. Sizes, weights and finishes may change without previous notice.
 È vietata la riproduzione del seguente documento senza previa autorizzazione scritta da parte di Pedrali SpA. Dimensioni, pesi e finiture possono variare senza alcun preavviso.

ST_BLUME_BLT_BLTD_2021.0

BLTD - BLT

DESIGN
Sebastian Herkner

MATERIALS

Materiali
Materialien
Matériaux
Materiales

• TOP - RIPIANO - TISCHPLATTE - PLATEAU - SOBRE

EN: Solid laminate top
IT: Ripiano in stratificato
DE: Kompakt-Tischplatte
FR: Plateau stratifiés
ES: Sobre compacto

TOP FINISH - FINITURA RIPIANO - AUSFÜHRUNG DER TISCHPLATTE - FINITION PLATEAU - ACABADO SOBRE



CFC_BI

TOP / RIPIANO / TISCHPLATTE / PLATEAU / SOBRE

10 mm thickness / Spessore 10 mm / Stärke 10 mm / Épaisseur 10 mm / Espesor 10 mm

Flat edge / Bordo piatto / Flache Kante / Chant plat / Canto rec

White core / Anima bianca / Weißer Kern / Coeur blanc / Alma blanco



FNP_NE* FNP_3452*

***Anti-fingerprint finish**

Finitura anti-impronta

TOP / RIPIANO / TISCHPLATTE / PLATEAU / SOBRE

10 mm thickness / Spessore 10 mm / Stärke 10 mm / Épaisseur 10 mm / Espesor 10 mm

Flat edge / Bordo piatto / Flache Kante / Chant plat / Canto rect

Black core / Anima nera / Schwarzer kern / Coeur noir / Alma negra



FNP_3455*

***Anti-fingerprint finish**

Finitura anti-impronta

TOP / RIPIANO / TISCHPLATTE / PLATEAU / SOBRE

10 mm thickness / Spessore 10 mm / Stärke 10 mm / Épaisseur 10 mm / Espesor 10 mm

Flat edge / Bordo piatto / Flache Kante / Chant plat / Canto rect

White core / Anima bianca / Weißer Kern / Coeur blanc / Alma blanco

• TOP - RIPIANO - TISCHPLATTE - PLATEAU - SOBRE

EN: Marble top

IT: Ripiano in marmo
DE: Marmor-Tischplatte
FR: Plateau en marbre
ES: Sobre de mármol

TOP FINISH - FINITURA RIPIANO - AUSFÜHRUNG DER TISCHPLATTE - FINITION PLATEAU - ACABADO SOBRE



TOP / RIPIANO / TISCHPLATTE / PLATEAU / SOBRE

20 mm thickness / Spessore 20 mm / Stärke 20 mm / Épaisseur 20 mm / Espesor 20 mm

Flat edge / Bordo piatto / Flache Kante / Chant plat / Canto rec

• TOP - RIPIANO - TISCHPLATTE - PLATEAU - SOBRE

EN: Compite marble top

IT: Ripiano in agglomerato di marmo
DE: Marmor-Konglomerat
FR: Plateau en marbre aggloméré
ES: Sobre de mármol aglomerado

TOP FINISH - FINITURA RIPIANO - AUSFÜHRUNG DER TISCHPLATTE - FINITION PLATEAU - ACABADO SOBRE



TOP / RIPIANO / TISCHPLATTE / PLATEAU / SOBRE

12 mm thickness / Spessore 12 mm / Stärke 12 mm / Épaisseur 12 mm / Espesor 12 mm

Flat edge / Bordo piatto / Flache Kante / Chant plat / Canto rec

• FRAME - TELAIO - STRUKTUR - STRUCTURE - ARMAZÓN

EN: Legs in extruded anodized aluminum Ø19 mm, with a flower shaped section, seat support in steel tube sized 35x15 mm, black powder coated

IT: Gambe in estruso di alluminio anodizzato con sezione a fiore Ø19 mm, supporto sedile in tubo 35x15 mm in acciaio, verniciato a polvere nero

DE: Beine aus druckgussgegossenem Aluminium in Blumenform Ø19 mm, Sitz-Verstärkung aus Stahlrohr 35x15mm, pulverbeschichtet schwarz

FR: Pieds en aluminium extrudé anodisé Ø19 mm, section à fleur, support d'assise en tube acier 35x15 mm époxy noir

ES: Patas de aluminio extruido anodizado de Ø19 mm, con sección de flor, soporte de asiento en tubo de 35x15 mm en acero, pintado en polvo negro

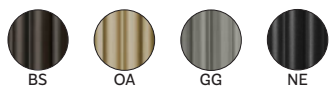

EN: For more information see finishing legend on the website

IT: Per maggiori informazioni vedere legenda finiture sul sito web

• FEET - PIEDINI - GLEITER - PATINS - TACOS

EN: In polyethylene, black

IT: In polietilene, nero
DE: Aus Polyethylen, schwarz
FR: En polyéthylène, noir
ES: De polietileno, negro

REGULATIONS AND CERTIFICATES

Normative e Certificazioni
Bestimmungen und Zertifikat
Normatives et certifications
Normativas y certificados

• ENVIRONMENTAL IMPACT - IMPATTO AMBIENTALE - UMWELTBELASTUNG - IMPACT SUR L'ENVIRONNEMENT - IMPACTO AMBIENTAL

MATERIAL Materiale	WEIGHT (Kg) Peso (Kg)	% ON TOTAL ITEM % su tot articolo	MATERIAL RECYCLABILITY Riciclabilita' del materiale	% RECYCLED AT ORIGIN % riciclato all'origine	% RECYCLABLE END OF PRODUCT LIFE % riciclabile fine vita prodotto
Steel Acciaio	3,93	6,01	YES	33,2	100
Extruded aluminium Alluminio estruso	1,12	1,71	YES	0	100
Zamak Zama	0,18	0,27	YES	50	100
Polypropylene Polipropilene	0,01	0,01	YES	0	100
Solid laminate Stratificato	6,41	9,79	NO	0	0
Marble Stratificato	53,8	82,21	YES	0	100
TOTAL TOTALE	65,44 Kg	--	--	2,1 %	90,2 %

EN: Percentages referred to BLT_99X99X45 (Marble)

IT: Percentuali riferite al BLT_99X99X45 (Marmo)

• COMPANY CERTIFICATIONS - CERTIFICAZIONI AZIENDALI - UNTERNEHMENSZERTIFIZIERUNGEN - CERTIFICATIONS D'ENTREPRISE - CERTIFICACIONES DE LA EMPRESA

ISO 14001
Environmental management system
Sistema di gestione ambientale



ISO 9001
Quality management system
Sistema di gestione della qualità

