



## Riverside

W 577 Giuseppe Iasparra

The Riverside collection contains classic linear elements and was designed to create flexible modern modular compositions that can cover every requirement of any given space. A range of dedicated complements and the option of matching different materials with a flexible selection in the measurements required complete this collection to make sure that it resolves every design requirement. The structure is in wood with high-resistance elastic bands, covered in high density polyurethane foam. Seat cushions are in multi-density polyurethane foam interiors with a rounded outer Memory Foam layer, all encased in soft sterilized goose down. Backrest cushions are filled with sterilized goose down, supported by a roller in high density polyurethane foam. On the roller upholstered in leather, it is possible to order a "Marlène" embroidered decoration. The elegant metal profile inserted in the armrest, the feet and all the metal accessories are offered in the following finishes: Black Rose gold, bright shaded brown, bright light gold, matt Champagne gold, bright chrome, bright black chrome, matt satin bronze, bright pink gold, matt pink gold. The upholstery CANNOT be removed from the structure, but the cushion covers in leather or fabric are removable.

Different types of dedicated small tables complete the collection:

- small service table with "wing shaped" shelf covered in leather or particular perforated Nubuck. They have the same strip design on the structural base, and offer a refined solution for holding objects and also for storage.
- small table in onyx and or Patagonia marble backlit.
- small end table shaped round in marble from the catalogue, base in wood: glossy/matt ebony, Canaletto walnut stained gloss/matt Macadamia, glossy/matt Sycamore frisè and support columns Ø 14 mm in coordinated metal,
- shaped small table in marble from the catalogue, base in wood: glossy/matt ebony, Canaletto walnut stained gloss/matt Macadamia, glossy/matt Sycamore frisè, and support columns Ø 14 mm in coordinated metal.

# TECHNICAL DRAWINGS

scala 1:50

Divani / Sofas / Диваны

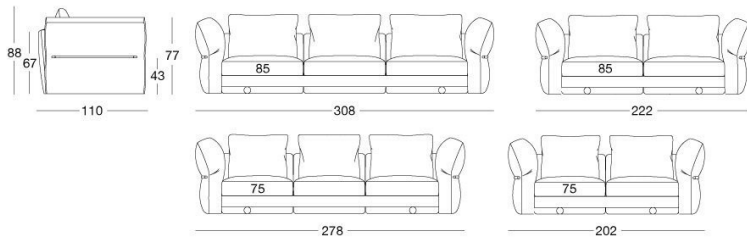

Terminali Sx / End unit L.H. / Боковые секции Л

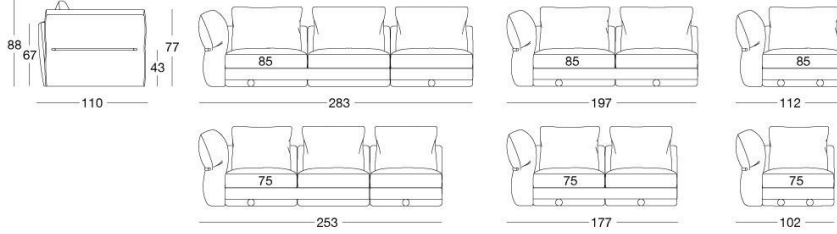

Terminali Dx / End unit R.H. / Боковые секции П

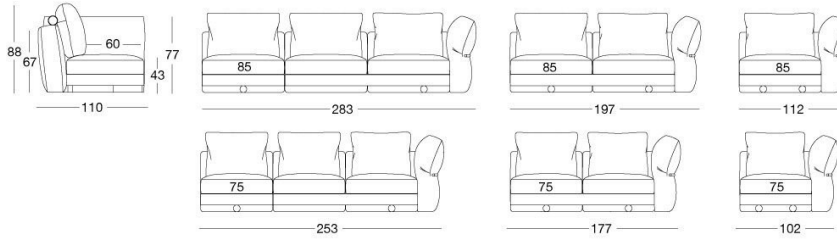

Terminali Sx con schienale allungato / Left end unit with extended back / Боковая секция с удлиненной спинкой левая

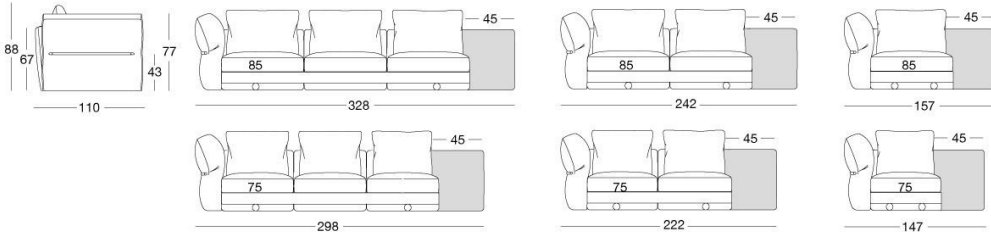

Terminali Dx con schienale allungato / Right end unit with extended back / Боковая секция с удлиненной спинкой правая

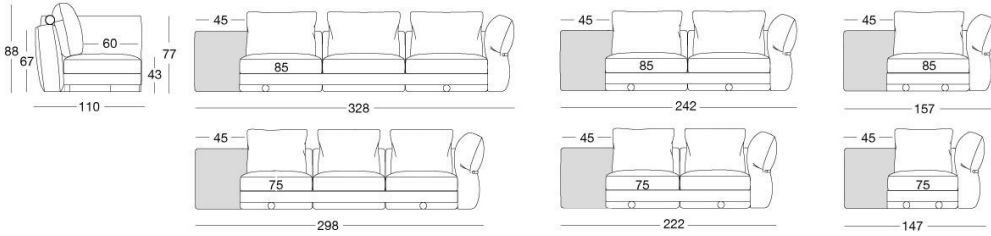

Centrali / Central / Центральные секции

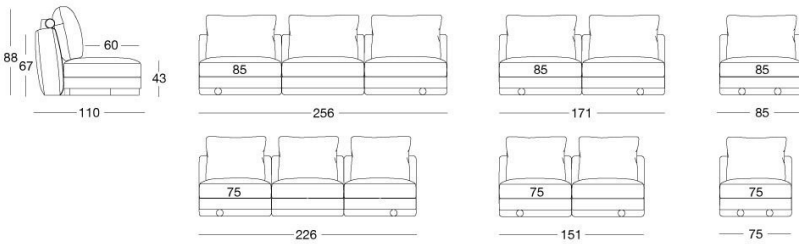

Centrali con schienale allungato Dx / Central unit with extended back Right / Центральная секция с удлиненной спинкой правая

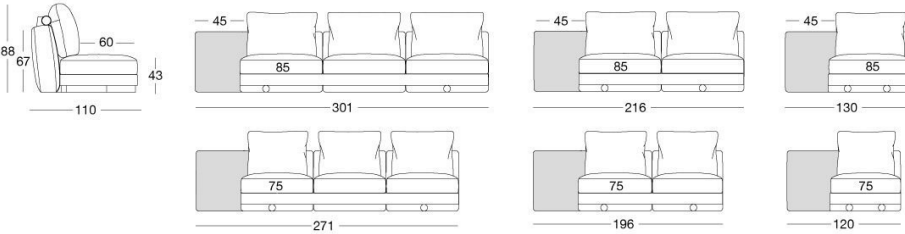

Centrali con schienale allungato Sx / Central unit with extended back Left / Центральная секция с удлиненной спинкой левая

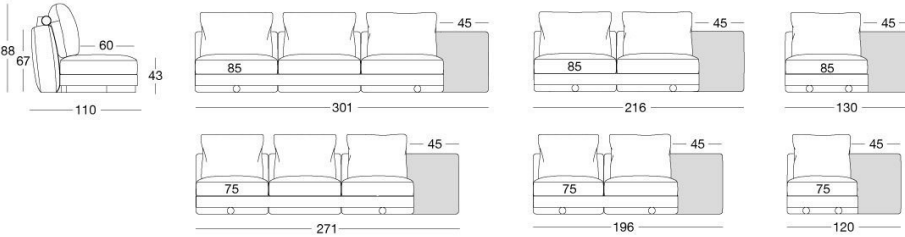

Poltrona / Armchair / Кресло

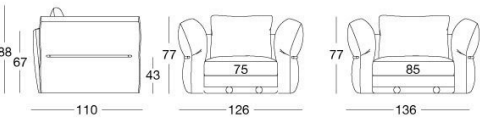

Dormeuse / Sofa peninsula / Диван

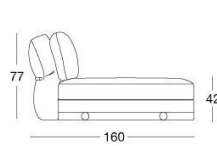

Pouf / Pouf / Пуф

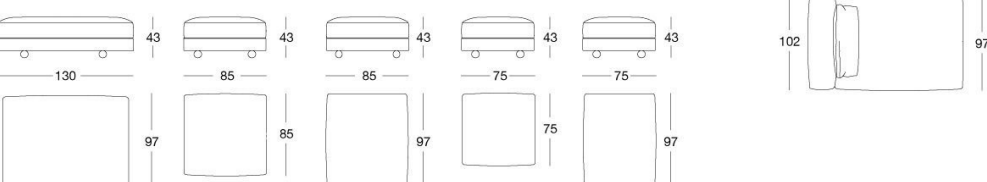

Penisola con braccioli / Chaise longue with armrests / шезлонг с подлокотниками

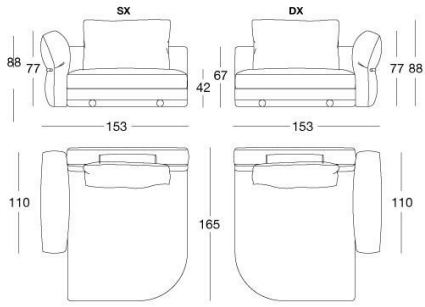

Penisola senza braccioli / Chaise longue without armrests / шезлонг без подлокотников

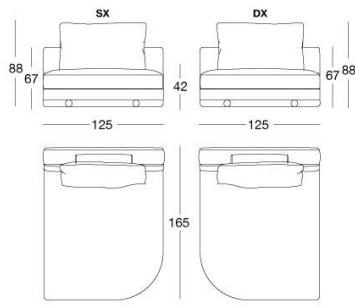

Angolo aperto / Open corner / Открытый угловой элемент

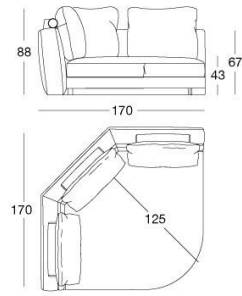

Angolo chiuso / Closed corner / Закрыто угловой элемент

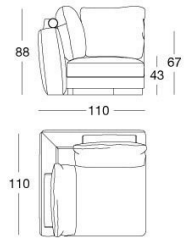

Accessori per elemento terminale / End unit accessories / Аксессуары для боковой секции

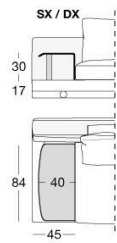

Tavolino di servizio rivestito  
Veneered service table  
Сервировочный столик с покрытием

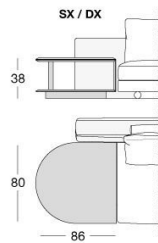

Tavolino in marmo tondo  
Round marble small table  
Столик из мрамора круглый

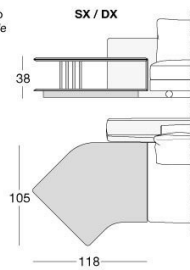

Tavolino in marmo sagomato  
Shaped marble small table  
Столик из мрамора профилированный

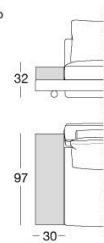

Tavolino in onice o marmo Patagonia  
Onyx or Patagonia marble small table  
Столик из оникса-Patagonia мрамор